



ARP-5517AX

NEMA 4X Waterproof Panel PC with 17-inch Touch Screen



Features

- 17" LCD, 1280 x 1024 Resolution
- 5-Wire Resistive Touch
- Stainless Steel Enclosure
- Meets NEMA 4X requirements
- Intel Celeron J1900 @ 1.99GHz / Atom E3845 @ 1.91GHz CPU; Intel i7-6600U CPU
- Up to 8GB DDR3/ Up to 16GB DDR4 SO-DIMM
- 1x Gigabit Ethernet
- 2x USB 2.0 ports
- Optional 2.5" SSD
- Wi-Fi Connectivity (Optional)
- 24VDC Operating Voltage

Specifications

Model Name	ARP-5517AX	
	E01	H01
LCD Display		
Display Size (Diagonal)	17.0 inch	17.0 inch
Max Resolution	1280 x 1024	1280 x 1024
Backlight Lifetime (Hours)	50,000 hours	50,000
Visual Characteristics		
Colors	16.7 million	16.7 million
Aspect Ratio	5:4	5:4
Viewing Angle (V/H)	160° / 140°	160° / 140°
Contrast Ratio	800 : 1	800 : 1
Brightness	350 nits	350 nits (max)
Touchscreen		
Technology	5 Wire Resistive	5 Wire Resistive
Interface	USB	USB
Driver	Windows 7, Windows 10	Windows 7, Windows 10
Enclosure		
NEMA 4	N/A	N/A
NEMA 4x	Stainless Steel	Stainless Steel
System		
CPU	Intel Celeron J1900 @ 1.99GHz / Atom E3845 @ 1.91GHz CPU	Intel i7-6600U
Chipset	Bay Trail	By CPU
Memory	Up to 8GB DDR3L SO-DIMM	Up to 16GB DDR4 SO-DIMM
Video Controller	Intel Gen7 Intel Graphics DX 11, OGL3.2	Intel HD Graphics 520
External Video Output	N/A	N/A
Storage Option	Optional 2.5" SSD	Optional 2.5" SSD
Compact Flash	N/A	N/A
Keyboard / Mouse	USB	USB
Audio	N/A	N/A
Watchdog Timer	Programmable 1 - 255 sec	Programmable 1 - 255 sec
Remote Boot	ThinManager Ready, PXE	N/A
Expansion Slot	N/A	N/A
I/O Communication		
USB Port	2 x USB 2.0	2 x USB 2.0
Serial Port	N/A	N/A
IEEE 1394	N/A	N/A
LAN	1 x Gigabit	1 x Gigabit
Parallel	N/A	N/A
GPIO	N/A	N/A
Smart Battery		
External Smart Battery	N/A	N/A
OS Support		
OS Support	Windows 7, Windows 10	Windows 7, Windows 10
Power/Thermal Specs		
Power Requirement (Max)	24VDC / 1.25A	24VDC / 2.2A
Power Consumption (Max)	30 W	51W
Recommended Power Supply	43 W	75W
Heat Dissipation	103 BTU/hr	174 BTU/hr
Physical Information		
Mounting	Pedestal, VESA, Wall and Ceiling mount, Benchtop	Pedestal, VESA, Wall and Ceiling mount, Benchtop
Net Weight	34 Lbs / 15.42 Kg	34 Lbs / 15.42 Kg
Dimension (W x H x D)	15.88 x 14.07 x 4.36 inch 403.4 x 357.4 x 110.7 mm	15.88 x 14.07 x 4.36 inch 403.4 x 357.4 x 110.7 mm
Recommended Cutout Dimension (WxH)	N/A	N/A
Environmental		
Operating Temperature	0~50°C (32~122°F)	0~50°C (32~122°F)
Storage Temperature	-20~60°C (-4~140°F)	-20~60°C (-4~140°F)
Relative Humidity	0~95%	0~95%
IP/NEMA Rating	Meets NEMA 4X	Meets NEMA 4X
Certification	UL60950	UL60950

Dimension Drawing

Model Name: ARP-5517AX
Size Unit: inch(mm)

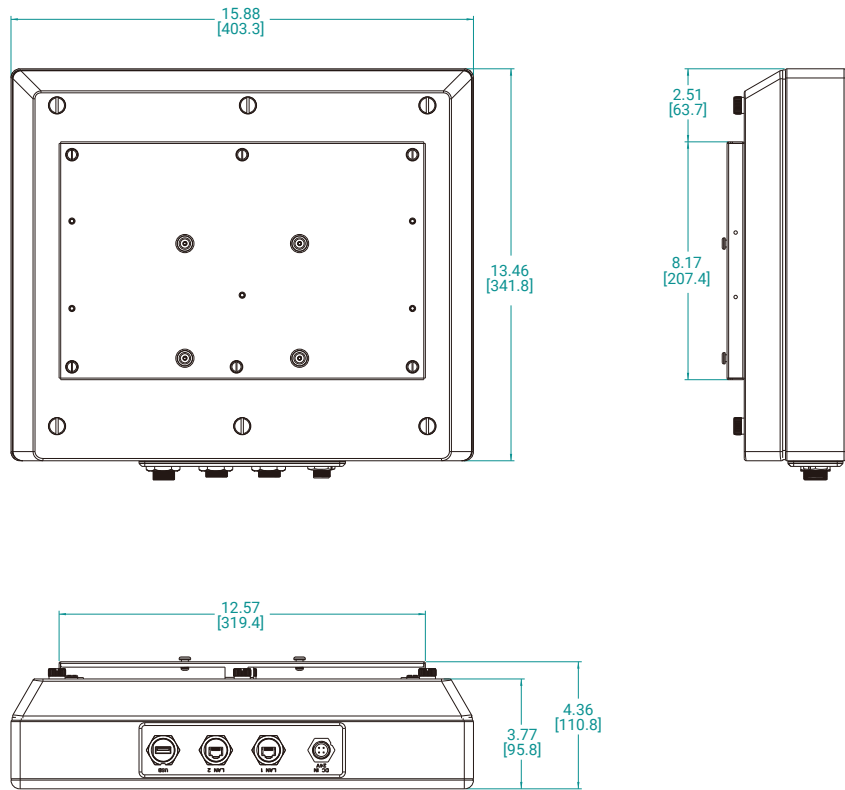

Ordering Information

Item	ARP-5517AX-E01-006
LCD Display	17.0" LCD / 1280 x 1024
Touch Screen	5-Wire
Enclosure	Stainless Steel
CPU	Intel Celeron J1900 @ 1.99GHz / Atom E3845 @ 1.91GHz CPU
Memory	4GB DDR3
Storage	N/A
Remote Boot	ThinManager Ready
Power Supply	24VDC INPUT

Item	ARP-5517AX-H01-034-700	ARP-5517AX-H01-035-700
LCD Display	17.0" LCD / 1280 x 1024	17.0" LCD / 1280 x 1024
Touch Screen	5-Wire	5-Wire
Enclosure	Stainless Steel	Stainless Steel
CPU	Intel 2.6/3.4 GHz i7-6600U	Intel 2.6/3.4 GHz i7-6600U
Memory	16GB DDR4	16GB DDR4
Storage	2.5" SATA SSD	2.5" SATA SSD
Remote Boot	N/A	N/A
Power Supply	24VDC INPUT	DIN-Rail Power Supply